

Designing for Resilience

Te Nikau | Grey Hospital
and Health Centre

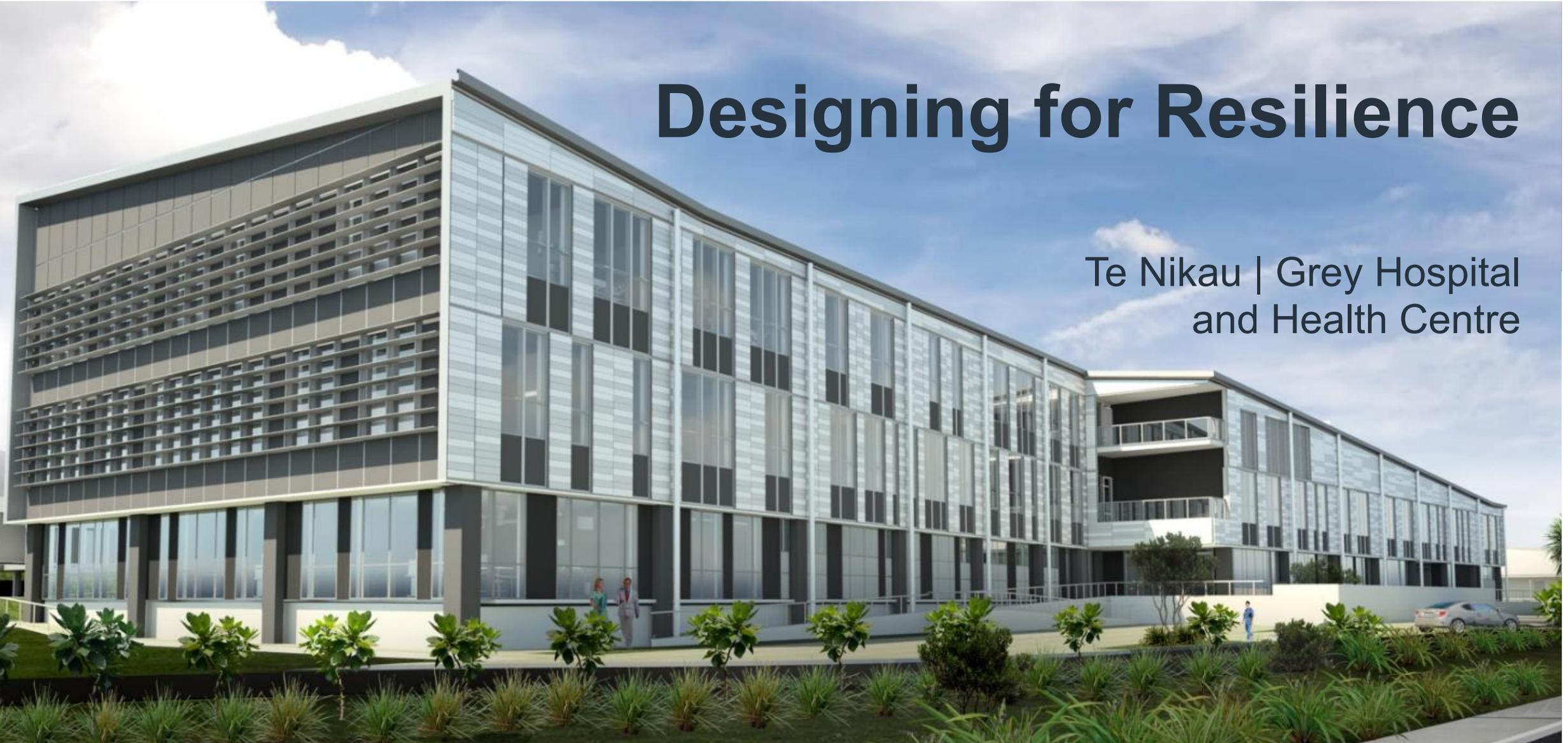



CCM ARCHITECTS

JACOBS



OPUS

New Zealand Government



West Coast
- District Health Board -
Te Pooti Hauora o Reko o Tai Poutini

CCM ARCHITECTS

JACOBS



OPUS

New Zealand Government



Tsunami



Earthquake



Heavy
Rainfall



Cyclones



Tornadoes

We're rural

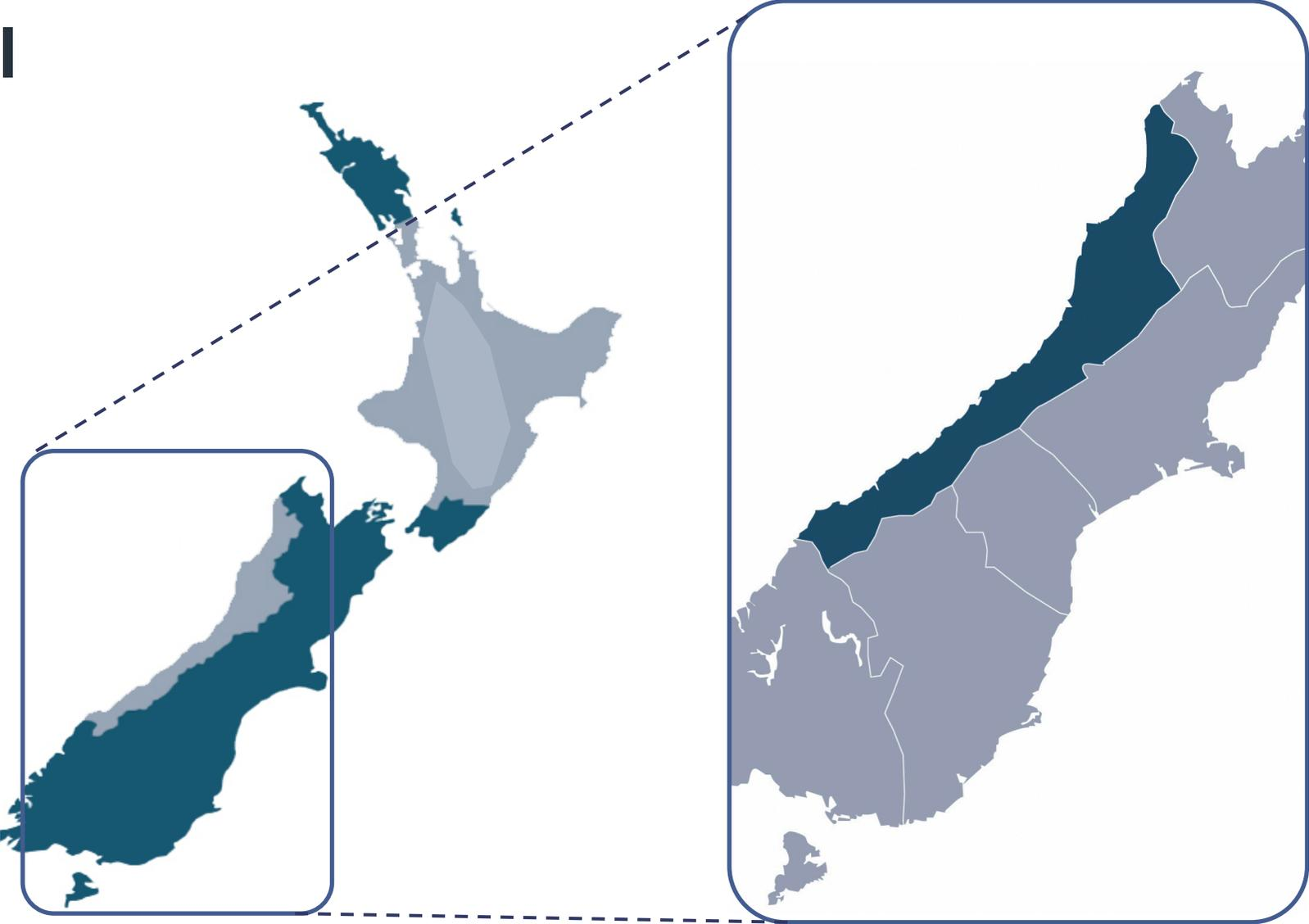

An integrated health system

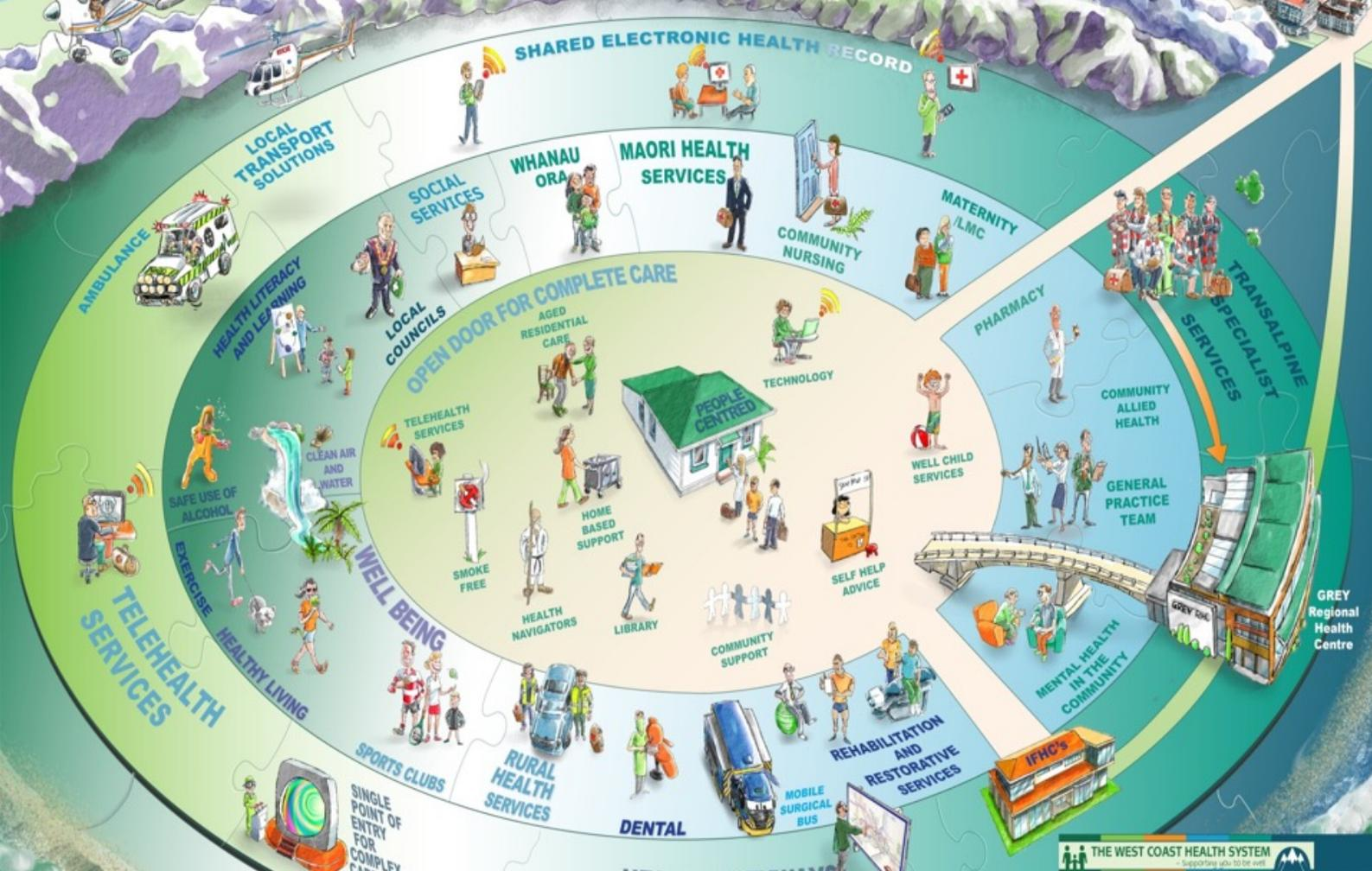

Model of care development

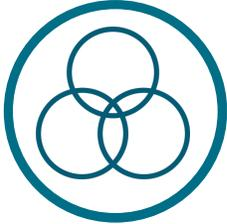

Integrated services



Patient at centre of care



Care closer to home



ICT enabled

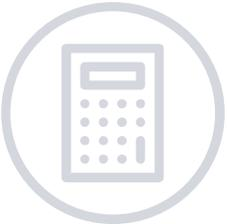

Financially and clinically sustainable



Strengthened responsiveness to Maori Health



Fit for purpose facilities

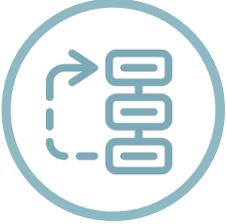

Prioritising resources

Existing facility



Design resilience

- Flexibility in the planning – blurred edges
- Seismic resilience
- Durability
- Sustainability

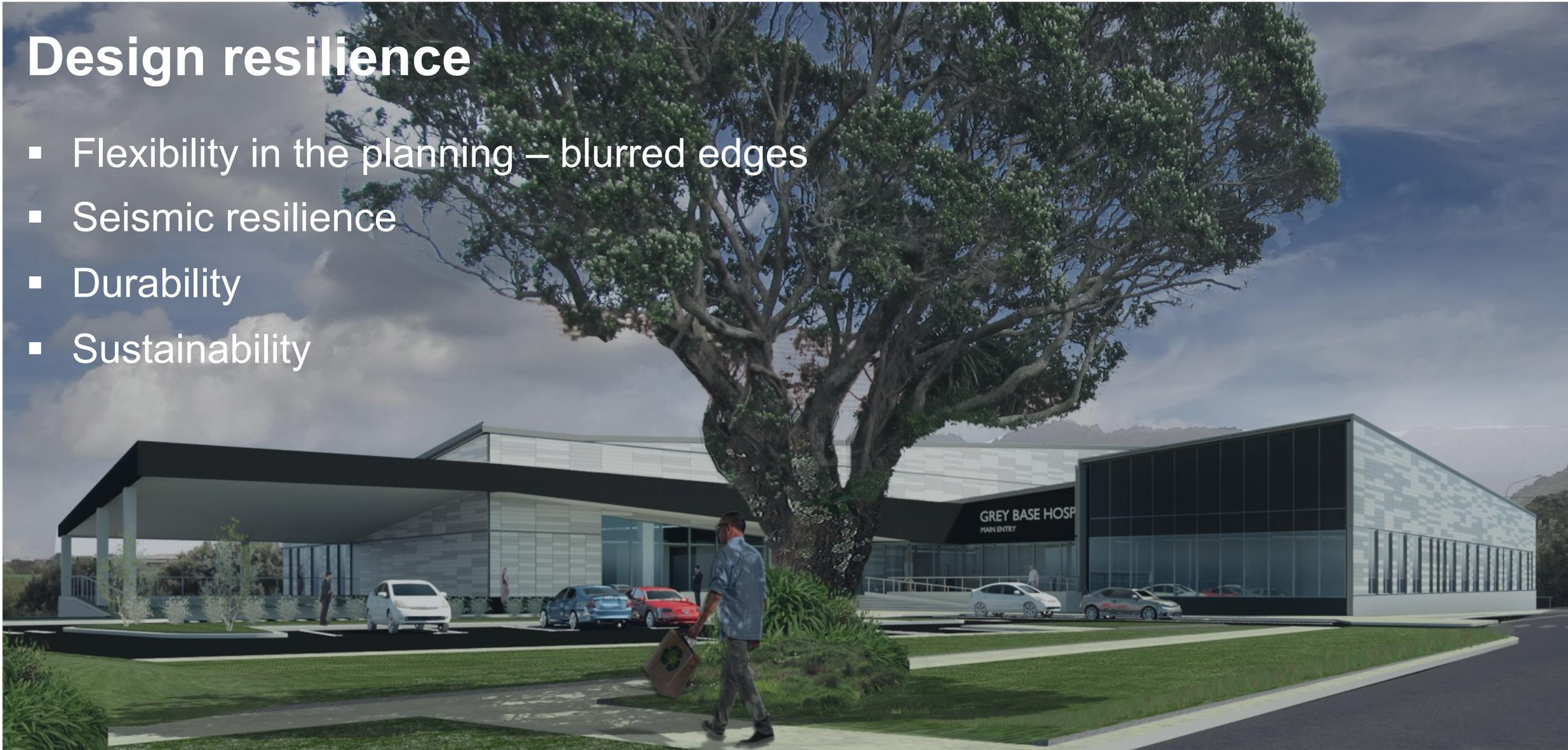



Flexibility in the planning- blurred edges

Site plan

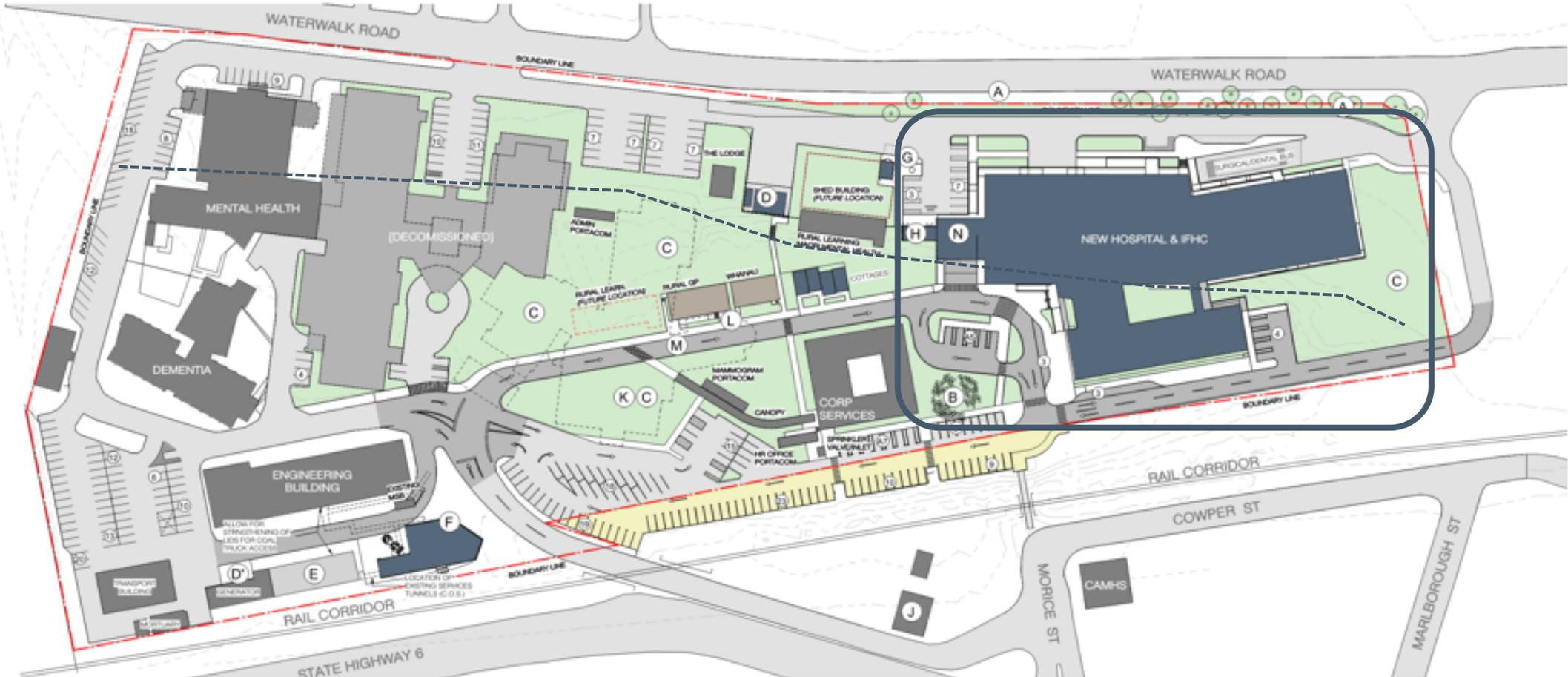

CCM ARCHITECTS

JACOBS



OPUS

New Zealand Government

Cross section

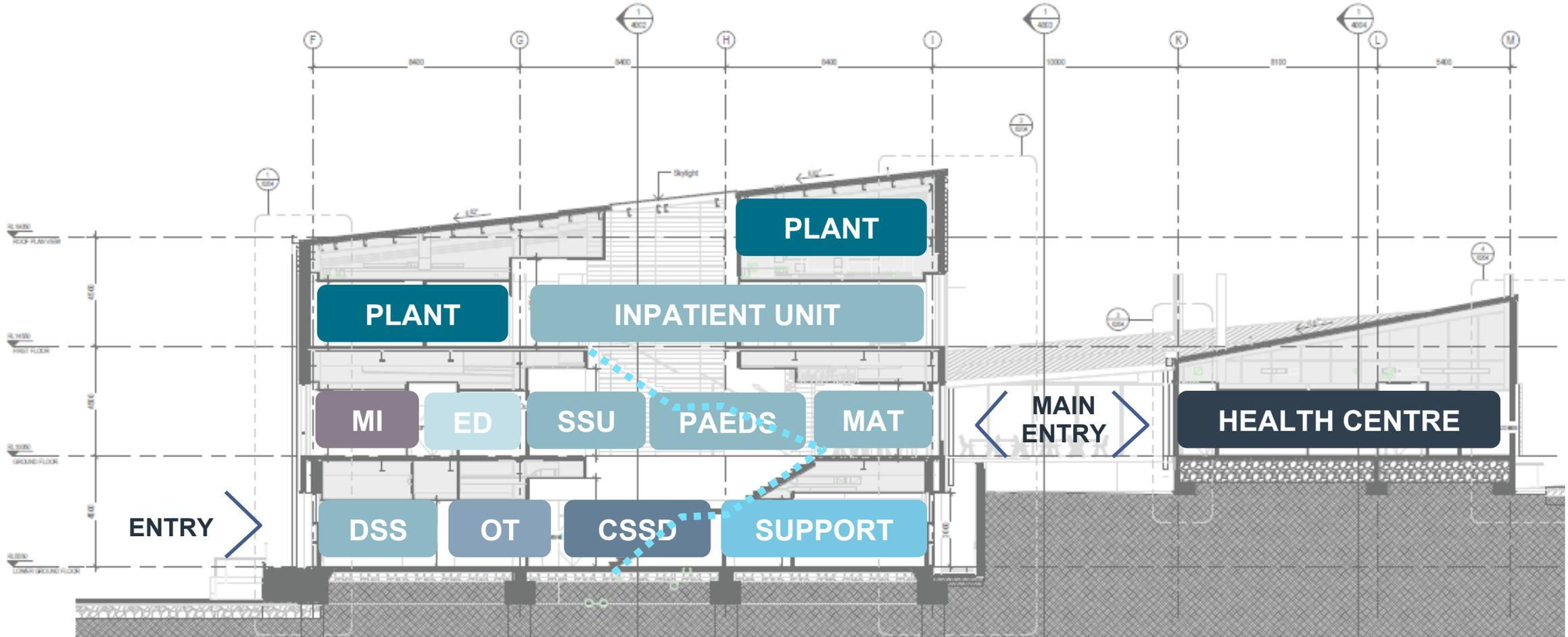

Lower ground floor departments

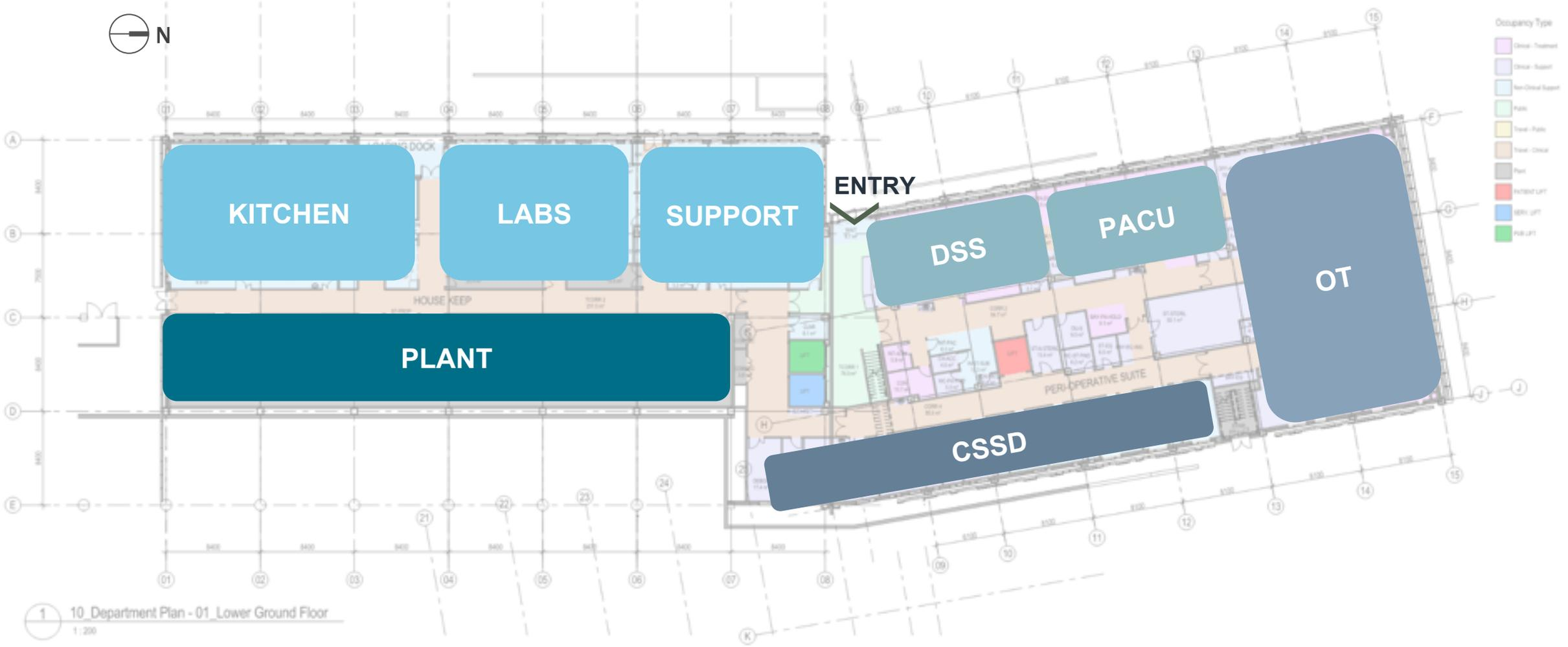

Ground floor departments

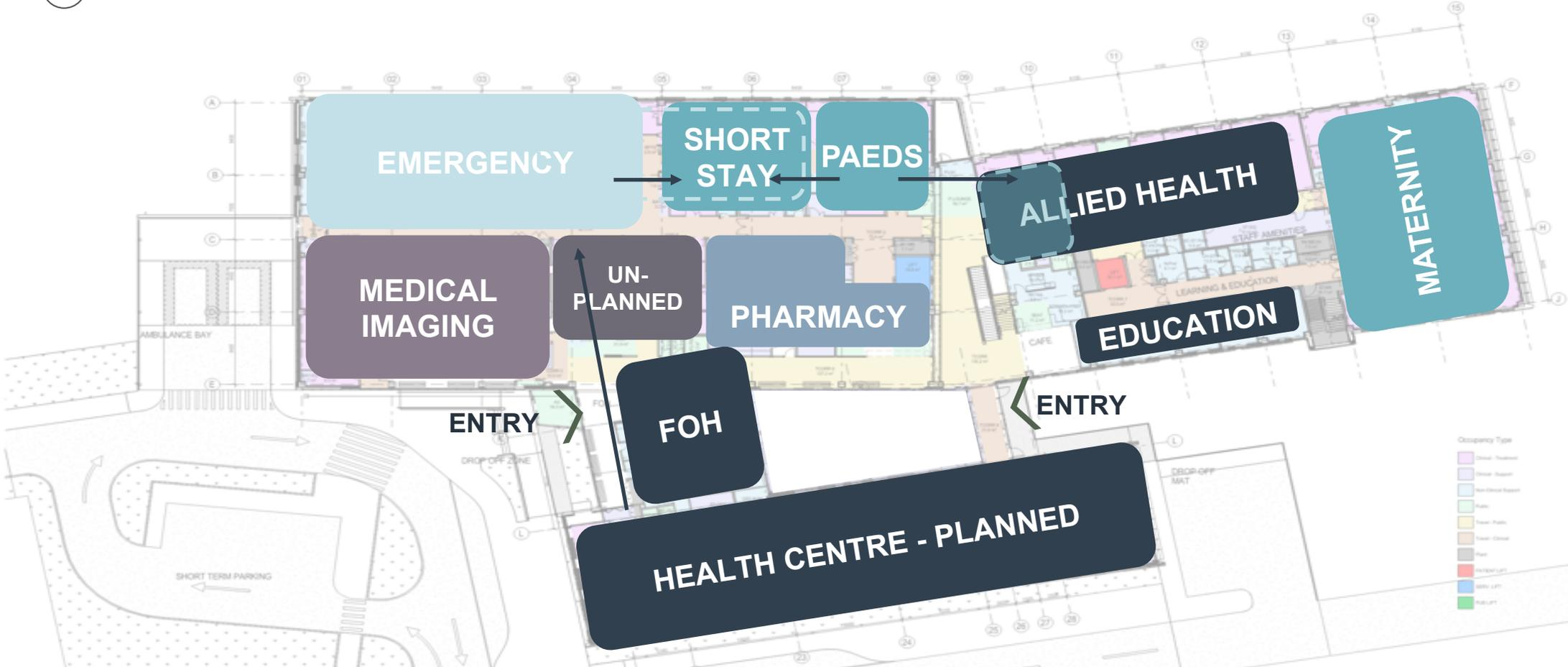

First floor departments

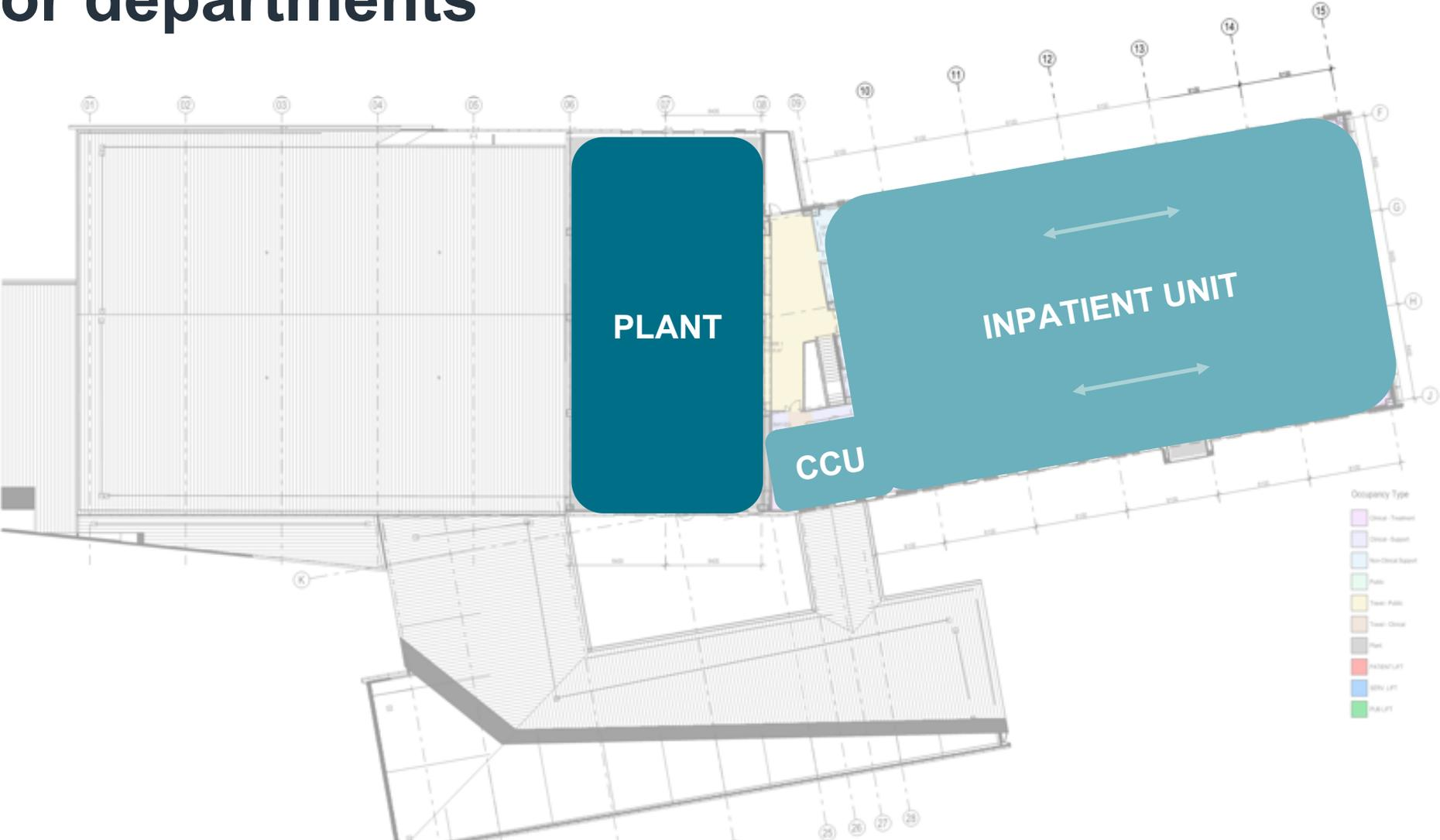

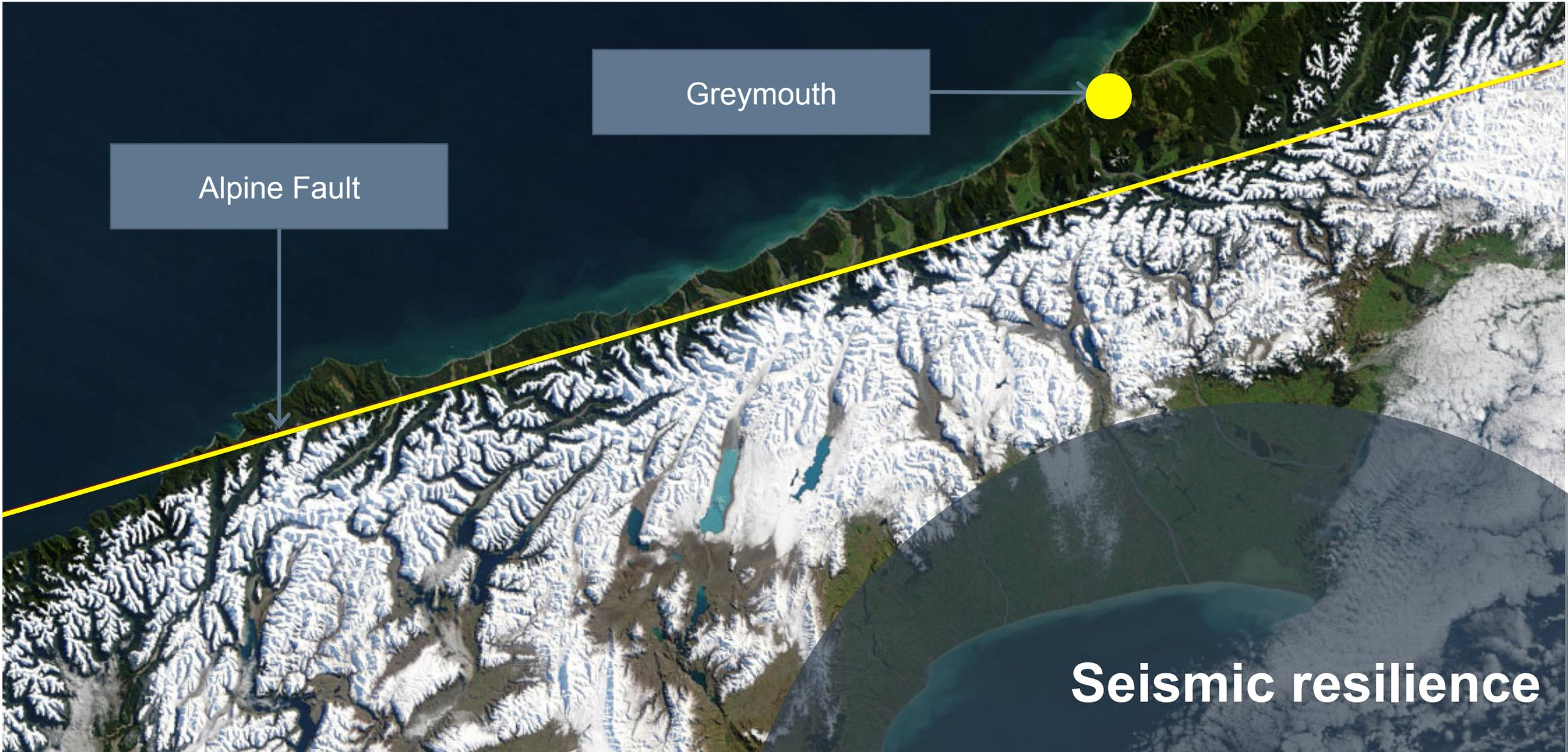

Alpine Fault

Greymouth

Seismic resilience

Seismic resilience - Greymouth response

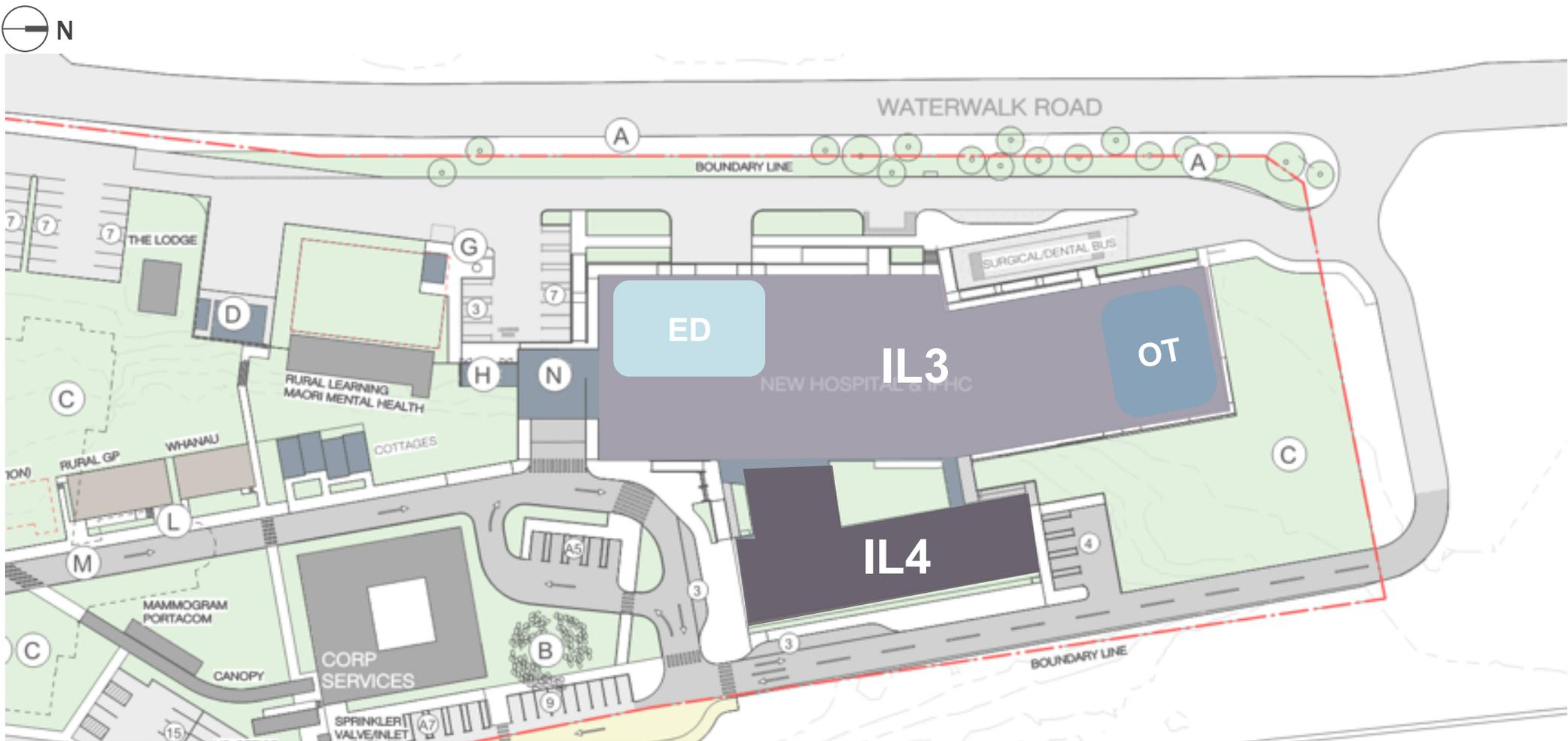



Durability



West Coast
District Health Board
Tū Peeri Hāora a Rōhe o Tai Poutini

CCM ARCHITECTS

JACOBS



OPUS

New Zealand Government



Sustainability



CCM ARCHITECTS

JACOBS



OPUS

New Zealand Government



Sustainability



West Coast
District Health Board
Te Peeri Hōuanga a Rōhe o Tai Poutini

CCM ARCHITECTS

JACOBS



OPUS

New Zealand Government



Resilient infrastructure



Post disaster functionality



Post disaster functionality

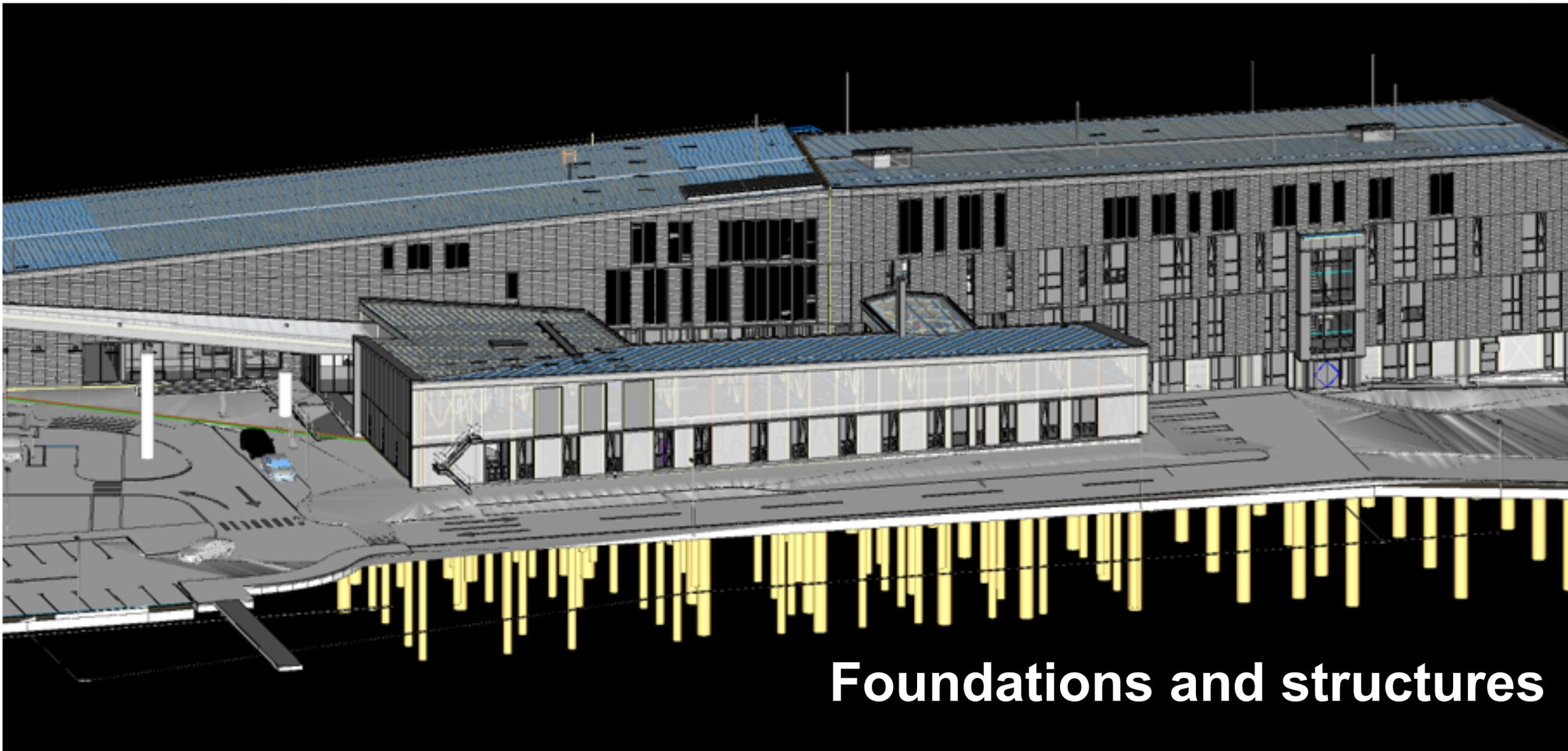

Foundations and structures



CCM ARCHITECTS

JACOBS



OPUS

New Zealand Government



Foundations and structures



CCM ARCHITECTS

JACOBS

WSP | OPUS

New Zealand Government



Foundations and structures

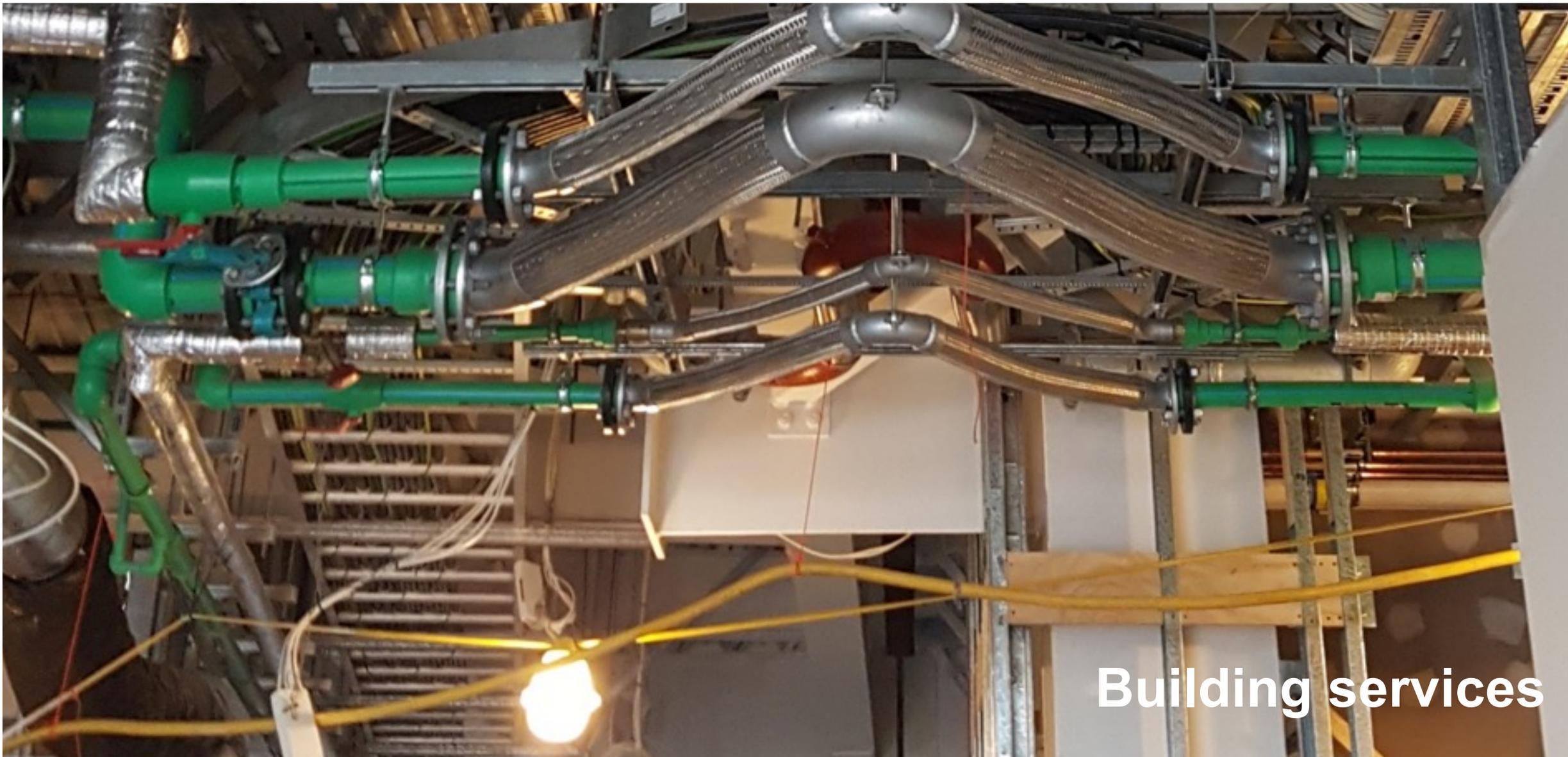

Building services



West Coast
District Health Board
Te Peeri Hāora o Reko o Tai Poutini

CCM ARCHITECTS

JACOBS



OPUS

New Zealand Government

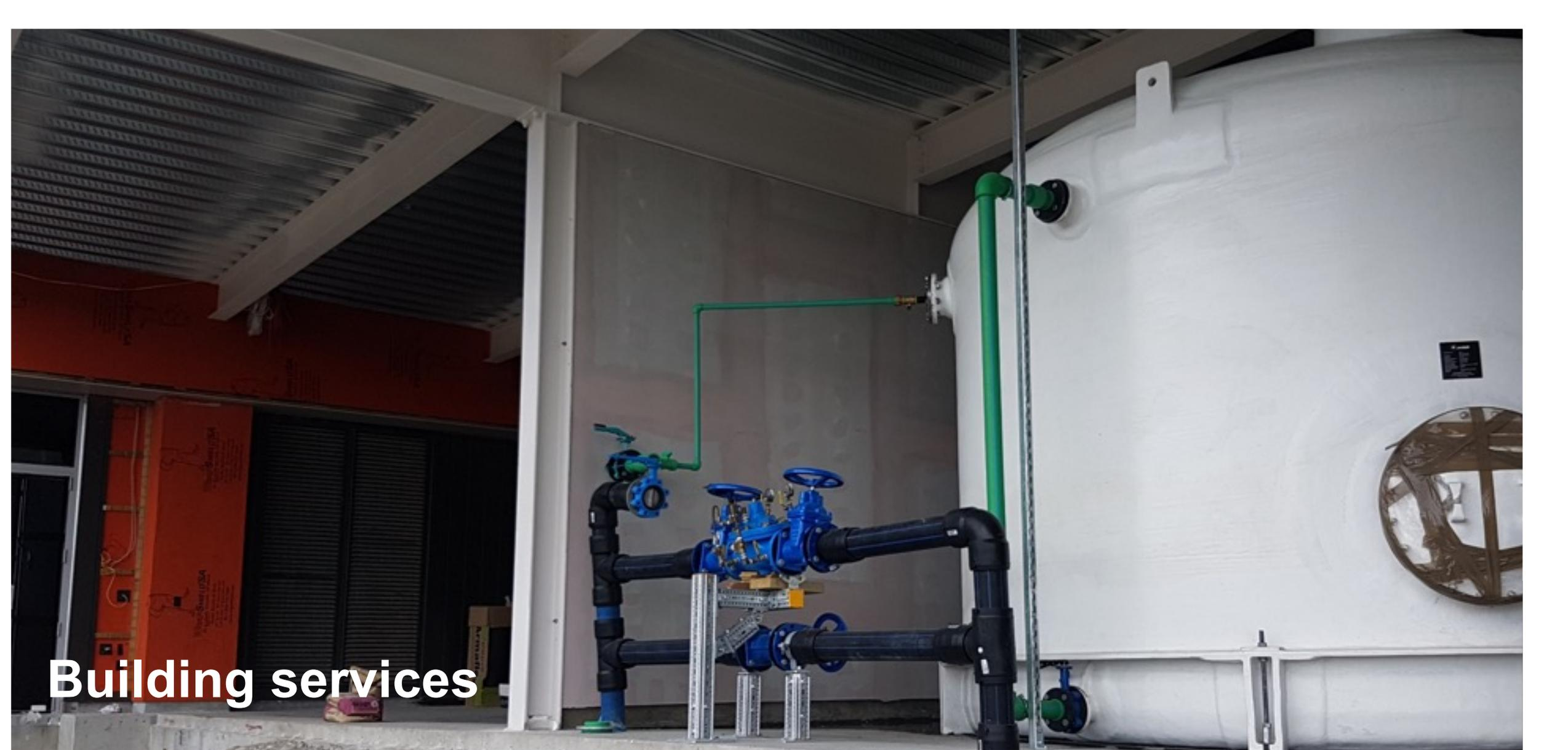

Building services



CCM ARCHITECTS

JACOBS



OPUS

New Zealand Government

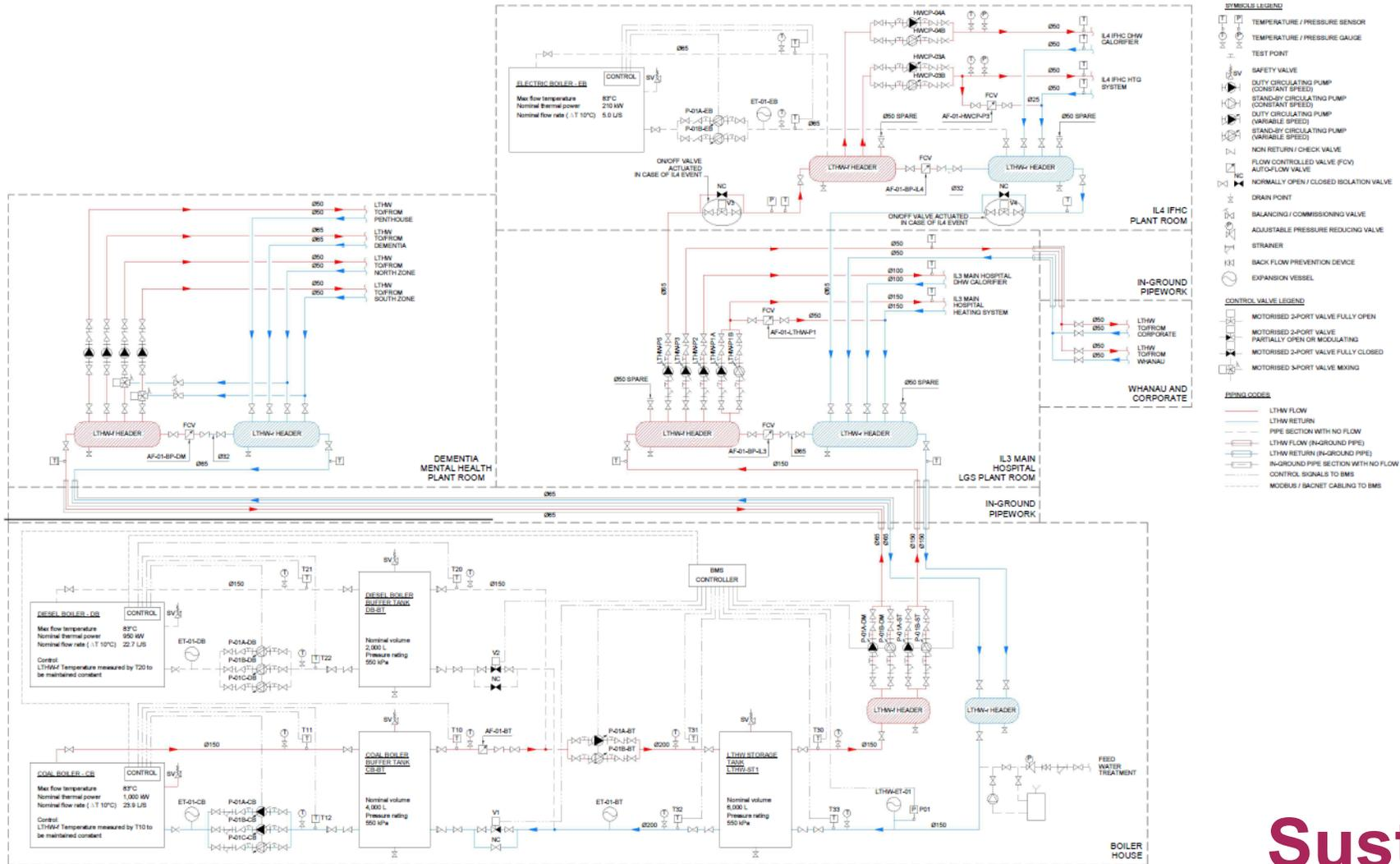

Sustainability

- NATURAL VENTILATION & RADIATOR
- 600W OPENABLE WINDOW
- 1200W OPENABLE WINDOW

Kia Ora



West Coast
District Health Board
Te Peeri Hanera a Roke o Tai Poutini

CCM ARCHITECTS

JACOBS



OPUS

New Zealand Government

Designing for Resilience

Te Nikau | Grey Hospital
and Health Centre

